



## 9 1 1 3

Temperature /  
mA Converter

No. 9113V106-UK

Product version: 9113-004



- DK** ▶ PR electronics A/S tilbyder et bredt program af analoge og digitale signalbehandlingsmoduler til industriel automation. Programmet består af Isolatorer, Displays, Ex-barrierer, Temperaturtransmittere, Universaltransmittere mfl. Vi har modulerne, du kan stole på i selv barske miljøer med elektrisk støj, vibrationer og temperaturudsving, og alle produkter opfylder de strengeste internationale standarder. Vores motto »Signals the Best« er indbegrebet af denne filosofi - og din garanti for kvalitet.
- UK** ▶ PR electronics A/S offers a wide range of analog and digital signal conditioning devices for industrial automation. The product range includes Isolators, Displays, I.S. Interfaces, Temperature Transmitters, and Universal Devices. You can trust our products in the most extreme environments with electrical noise, vibrations and temperature fluctuations, and all products comply with the most exacting international standards. »Signals the Best« is the epitome of our philosophy - and your guarantee for quality.
- FR** ▶ PR electronics A/S offre une large gamme de produits pour le traitement des signaux analogiques et numériques dans tous les domaines industriels. La gamme de produits s'étend des transmetteurs de température aux afficheurs, des isolateurs aux interfaces SI, jusqu'aux modules universels. Vous pouvez compter sur nos produits même dans les conditions d'utilisation sévères, p.ex. bruit électrique, vibrations et fluctuations de température. Tous nos produits sont conformes aux normes internationales les plus strictes. Notre devise »SIGNALS the BEST« c'est notre ligne de conduite - et pour vous l'assurance de la meilleure qualité.
- DE** ▶ PR electronics A/S verfügt über ein breites Produktprogramm an analogen und digitalen Signalverarbeitungsgeräte für die industrielle Automatisierung. Dieses Programm umfasst Displays, Temperaturtransmitter, Ex- und galvanische Signaltrenner, und Universalgeräte. Sie können unsere Geräte auch unter extremen Einsatzbedingungen wie elektrisches Rauschen, Erschütterungen und Temperaturschwingungen vertrauen, und alle Produkte von PR electronics werden in Übereinstimmung mit den strengsten internationalen Normen produziert. »Signals the Best« ist Ihre Garantie für Qualität!

# TEMPERATURE / mA CONVERTER

## 9113

### CONTENTS

Warning.....	2
Symbol identification .....	2
Safety instructions.....	2
How to demount system 9000 .....	4
Advanced features .....	5
Application.....	5
Technical characteristics.....	5
Applications.....	6
PR 4501 display / programming front.....	7
Mounting / demounting the PR 4501/4511.....	8
Ordering codes for 9113B.....	9
Accessories .....	9
Electrical specifications.....	9
Configuration of sensor error check.....	14
Input signal outside range .....	14
Sensor error detection .....	14
Error indications.....	14
Connections .....	16
Block diagram.....	17
Signal error and cable fault indications without display front.....	18
Configuration / operating the function keys.....	19
Routing diagram.....	22
Routing diagram, Advanced settings (ADV.SET).....	24
Scrolling help texts in display line 3.....	25
Appendix.....	26
IECEX Installation Drawing.....	27
ATEX Installation Drawing.....	30
FM Installation Drawing .....	33
INMETRO Installation Drawing .....	36
Safety Manual.....	39



## WARNING

The following operations should only be carried out on a disconnected device and under ESD-safe conditions:

- General mounting, connection and disconnection of wires.
- Troubleshooting the device.

**Repair of the device and replacement of circuit breakers must be done by PR electronics A/S only.**



## WARNING

Do not open the front plate of the device as this will cause damage to the connector for the display / programming front PR 4501. This device contains no DIP-switches or jumpers.

## SYMBOL IDENTIFICATION



**Triangle with an exclamation mark:** Read the manual before installation and commissioning of the device in order to avoid incidents that could lead to personal injury or mechanical damage.



**The CE mark** proves the compliance of the device with the essential requirements of the directives.



**The double insulation symbol** shows that the device is protected by double or reinforced insulation.



**Ex devices** have been approved according to the ATEX directive for use in connection with installations in explosive areas.

## SAFETY INSTRUCTIONS

### DEFINITIONS

**Hazardous voltages** have been defined as the ranges: 75...1500 Volt DC, and 50...1000 Volt AC.

**Technicians** are qualified persons educated or trained to mount, operate, and also troubleshoot technically correct and in accordance with safety regulations.

**Operators**, being familiar with the contents of this manual, adjust and operate the knobs or potentiometers during normal operation.

## **RECEIPT AND UNPACKING**

Unpack the device without damaging it. The packing should always follow the device until this has been permanently mounted.

Check at the receipt of the device whether the type corresponds to the one ordered.

## **ENVIRONMENT**

Avoid direct sunlight, dust, high temperatures, mechanical vibrations and shock, as well as rain and heavy moisture. If necessary, heating in excess of the stated limits for ambient temperatures should be avoided by way of ventilation.

The device must be installed in pollution degree 2 or better.

The device is designed to be safe at least under an altitude up to 2 000 m.

## **MOUNTING**

Only technicians who are familiar with the technical terms, warnings, and instructions in the manual and who are able to follow these should connect the device.

Should there be any doubt as to the correct handling of the device, please contact your local distributor or, alternatively,

**PR electronics A/S**  
**[www.prelectronics.com](http://www.prelectronics.com)**

The use of stranded wires is not permitted for mains wiring except when wires are fitted with cable ends.

Descriptions of input / output and supply connections are shown in the block diagram and on the side label.

The device is provided with field wiring terminals and shall be supplied from a Power Supply having double / reinforced insulation. A power switch shall be easily accessible and close to the device. The power switch shall be marked as the disconnecting device for the device.

For installation on Power Rail 9400 the power is supplied by Power Control module 9410.

Year of manufacture can be taken from the first two digits in the serial number.

## **CALIBRATION AND ADJUSTMENT**

During calibration and adjustment, the measuring and connection of external voltages must be carried out according to the specifications of this manual. The technician must use tools and instruments that are safe to use.

## **NORMAL OPERATION**

Operators are only allowed to adjust and operate device that are safely fixed in panels, etc., thus avoiding the danger of personal injury and damage. This means there is no electrical shock hazard, and the device is easily accessible.

## **CLEANING**

When disconnected, the device may be cleaned with a cloth moistened with distilled water.

## **LIABILITY**

To the extent the instructions in this manual are not strictly observed, the customer cannot advance a demand against PR electronics A/S that would otherwise exist according to the concluded sales agreement.

## **HOW TO DEMOUNT SYSTEM 9000**

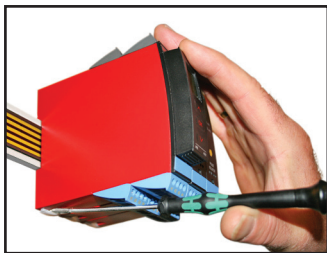

**Picture 1:**

By lifting the bottom lock, the device is detached from the DIN rail.

# TEMPERATURE / mA CONVERTER

## 9113

- *Input for RTD, TC and mA*
- *Active / passive mA output*
- *1 or 2 channels*
- *Can be supplied separately or installed on power rail, PR type 9400*
- *SIL 2-certified via Full Assessment*

### Advanced features

- Configuration and monitoring by way of detachable display front (PR 4501); process calibration and signal simulation.
- Copying of the configuration from one device to others of the same type via the display front.
- TC inputs can use either the internal CJC or a terminal with a built-in Pt100 sensor (PR 5910Ex, channel 1 / PR 5913Ex, channel 2) for higher accuracy.
- The device automatically detects whether it must supply an active or a passive current signal.
- Advanced monitoring of internal communication and stored data.
- SIL 2 functionality is optional and must be activated in a menu point.

### Application

- The device can be mounted in the safe area and in zone 2 / cl. 1 div. 2 and receive signals from zone 0, 1, 2 and zone 20, 21, 22 including M1 / Class I/II/III, Div. 1, Gr. A-G.
- Conversion and scaling of temperature (Pt, Ni and TC) and active current signals.
- The 9113 has been designed, developed and certified for use in SIL 2 applications according to the requirements of IEC 61508.

### Technical characteristics

- 1 green and 2 red front LEDs indicate operation status and malfunction.
- 2.6 kVAC galvanic isolation between input, output and supply.



## APPLICATIONS

### Input signals:

Channel 1:

Current

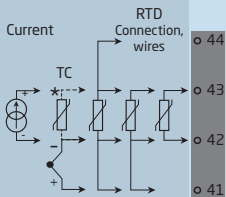

\*Order separately: CJC connector 5910Ex/5913Ex

Channel 2:

Current

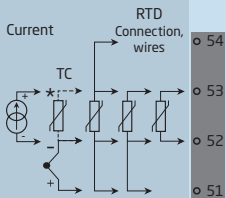

\*Order separately: CJC connector 5910Ex/5913Ex

**Zone 0, 1, 2,  
20, 21, 22, M1 &  
Cl. I/II/III, Div. 1  
gr. A-G**

### Output signals:

Analogue, 0/4...20 mA

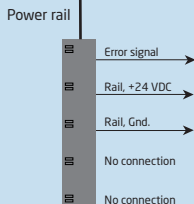
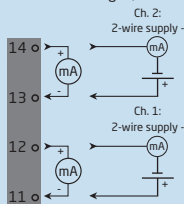

### Power connection:

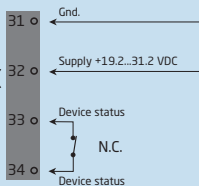

Supply via power rail

**Zone 2 / Cl. 1, div. 2, gr. A-D or safe area**



# PR 4501 DISPLAY / PROGRAMMING FRONT



## Functionality

The simple and easily understandable menu structure and the explanatory help texts guide you effortlessly and automatically through the configuration steps, thus making the product very easy to use. Functions and configuration options are described in the section "Configuration / operating the function keys".

## Application

- Communications interface for modification of operational parameters in 9113.
- Can be moved from one 9113 device to another and download the configuration of the first unit to subsequent units.
- When mounted in the process, the display shows process values and device status.

## Technical characteristics

- LCD display with 4 lines; Line 1 (H=5.57 mm) shows input status, line 2 and 3 (H=3.33 mm) show analogue input / output value or TAG no. and units, and line 4 shows status for communication and whether the device is SIL-locked. Static dot = SIL-locked and flashing dot = not SIL-locked.
- Programming access can be blocked by assigning a password. The password is saved in the device in order to ensure a high degree of protection against unauthorised modifications to the configuration.

## MOUNTING / DEMOUNTING THE PR 4501/4511

1: Insert the taps of 4501/4511 into the holes at the top of the device.

2: Swing 4501/4511 into place.

### Demounting of 4501/4511

3: Push the release button on the bottom of 4501/4511 and swing 4501/4511 up

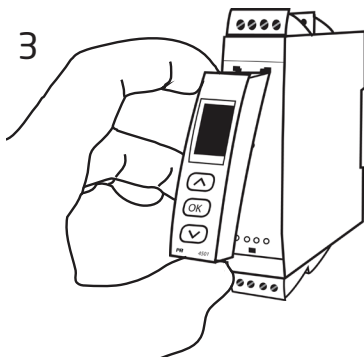
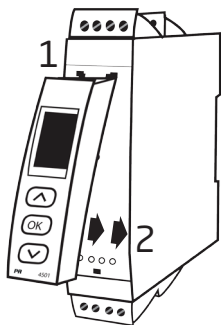

## Ordering codes for 9113B

Type	Channels
9113B	Single : A
	Double : B

### Accessories

4501 = Display / programming front  
4511 = Communication enabler  
5910Ex = CJC connector, channel 1  
5913Ex = CJC connector, channel 2  
9400 = Power rail  
9404 = Module stop for rail  
9410 = Power control unit  
9420 = Power supply 24 V / 120 W - Ex nAC

### Electrical specifications

#### Environmental conditions

Specifications range ..... -20...+60°C  
Storage temperature ..... -20...+85°C  
Calibration temperature ..... 20...28°C  
Relative humidity ..... < 95% RH (non-cond.)  
Protection degree ..... IP20  
Installation in ..... Pollution degree 2 & measurement /  
overvoltage category II

#### Mechanical specifications:

Dimensions (HxWxD) ..... 109 x 23.5 x 104 mm  
Dimensions (HxWxD) w/ 4501 / 4511 ..... 109 x 23.5 x 116 / 131 mm  
Weight approx. .... 250 g  
Weight incl. 4501 / 4511 (approx.) ..... 265 g / 350 g  
DIN rail type ..... DIN EN 60715 / 35 mm  
Wire size ..... 0.13...2.08 mm<sup>2</sup> AWG 26...14  
stranded wire  
Screw terminal torque ..... 0.5 Nm  
Vibration ..... IEC 60068-2-6 : 2007  
Vibration: 2...13.2 Hz ..... ±1 mm  
Vibration: 13.2...100 Hz ..... ±0.7 g

#### Common specifications:

Supply voltage, DC ..... 19.2...31.2 VDC  
Max. consumption ..... ≤ 3.5 W (2 channels)

Fuse.....	400 mA SB / 250 VAC
Isolation - test / working:	
Input to any .....	2.6 kVAC / 300 VAC reinforced
Analogue output to supply .....	2.6 kVAC / 300 VAC reinforced
Status relay to supply .....	1.5 kVAC / 150 VAC reinforced
Communications interface .....	Communication enabler 4511 / Programming front 4501
Signal / noise ratio .....	Min. 60 dB (0...100 kHz)
Average response time incl. delay:	
Temperature input .....	≤ 1 s
mA input .....	≤ 0.4 s
Accuracy, the greater of the general and basic values:	

General values		
Input type	Absolute accuracy	Temperature coefficient
All	≤ ±0.1% of span	≤ ±0.01% of span / °C

Basic values		
Input type	Basic accuracy	Temperature coefficient
mA	≤ ±16 µA	≤ ±1.6 µA / °C
Pt100, Pt200, Pt 1000	≤ ±0.2°C	≤ ±0.02°C / °C
Pt500, Ni100, Ni120, Ni 1000	≤ ±0.3°C	≤ ±0.03°C / °C
Pt50, Pt400, Ni50	≤ ±0.4°C	≤ ±0.04°C / °C
Pt250, Pt300	≤ ±0.6°C	≤ ±0.06°C / °C
Pt20	≤ ±0.8°C	≤ ±0.08°C / °C
Pt10	≤ ±1.4°C	≤ ±0.14°C / °C
TC type: E, J, K, L, N, T, U	≤ ±1°C	≤ ±0.1°C / °C
TC type: R, S, W3, W5, LR	≤ ±2°C	≤ ±0.2°C / °C
TC type: B 160...400°C	≤ ±4.5°C	≤ ±0.45°C / °C
TC type: B 400...1820°C	≤ ±2°C	≤ ±0.2°C / °C

EMC immunity influence .....	< ±0.5% of span
Extended EMC immunity: NAMUR NE 21, A criterion, burst .....	< ±1% of span

#### RTD input:

Input type	Min. value	Max. value	Standard
Pt100 Ni100	-200°C -60°C	+850°C +250°C	IEC60751 DIN 43760

Input for RTD types:

Pt10\*, Pt20\*, Pt50\*, Pt100, Pt200, Pt250, Pt300, Pt400, Pt500, Pt1000  
Ni50, Ni100, Ni120, Ni1000

Cable resistance per wire (max.) ..... 50 Ω

Sensor current..... Nom. 0.2 mA

Effect of sensor cable resistance

(3- / 4-wire)..... < 0.002 Ω / Ω

Sensor error detection..... Programmable ON / OFF

Sensor error current:

when detecting..... < 2 μA

else..... 0 μA

\* No short circuit detection for Pt10, Pt20 and Pt50

#### TC input:

Type	Min. value	Max. value	Standard
B	+0°C	+1820°C	IEC 60584-1
E	-100°C	+1000°C	IEC 60584-1
J	-100°C	+1200°C	IEC 60584-1
K	-180°C	+1372°C	IEC 60584-1
L	-200°C	+900°C	DIN 43710
N	-180°C	+1300°C	IEC 60584-1
R	-50°C	+1760°C	IEC 60584-1
S	-50°C	+1760°C	IEC 60584-1
T	-200°C	+400°C	IEC 60584-1
U	-200°C	+600°C	DIN 43710
W3	0°C	+2300°C	ASTM E988-90
W5	0°C	+2300°C	ASTM E988-90
LR	-200°C	+800°C	GOST 3044-84

Cold junction compensation (CJC):  
 via external sensor in connector 5910. 20...28°C ≤ ±1°C  
 -20...20°C and 28...70°C ≤ ±2°C  
 via internal CJC sensor..... ±(2.0°C + 0.4°C \* Δt)

Δt = internal temperature - ambient temperature

Sensor error detection..... Programmable ON or OFF  
 (only wire breakage)

Sensor error current:  
 when detecting..... Nom. 2 μA  
 else..... 0 μA

### Current input:

Measurement range..... 0...20 mA  
 Programmable measurement ranges..... 0...20 and 4...20 mA  
 Input resistance..... Nom. 20 Ω + PTC 50 Ω  
 Sensor error detection..... Programmable ON / OFF  
 Only 4...20 mA (NAMUR)

### Current output:

Signal range (span)..... 0...20 mA  
 Programmable signal ranges..... 0...20 / 4...20 /  
 20...0 and 20...4 mA  
 Load (max.)..... 20 mA / 600 Ω / 12 VDC  
 Load stability..... ≤ 0.01% of span / 100 Ω  
 Sensor error detection..... 0 / 3.5 / 23 mA / none  
 NAMUR NE 43 Upscale/Downscale..... 23 mA / 3.5 mA  
 Output limitation:  
 on 4...20 and 20...4 mA signals ..... 3.8...20.5 mA  
 on 0...20 and 20...0 mA signals ..... 0...20.5 mA  
 Current limit..... ≤ 28 mA

### 2-wire 4...20 mA output:

Signal range..... 4...20 mA  
 Load stability..... ≤ 0.01% of span / 100 Ω  
 Load resistance..... ≤ (V<sub>supply</sub> - 3.5) / 0.023 A [Ω]  
 External 2-wire supply range ..... 3.5...26 VDC  
 Effect of external 2-wire supply  
 voltage variation..... < 0.005% of span / V

### Status relay in safe area:

Max. voltage ..... 125 VAC / 110 VDC  
 Max. current..... 0.5 AAC / 0.3 ADC  
 Max. AC power ..... 62.5 VA / 32 W

**of span** = of the currently selected measurement range

**Approvals:**

EMC 2004/108/EC .....	EN 61326-1
LVD 2006/95/EC.....	EN 61010-1
c UL us, Standard for Safety.....	UL 61010-1
EAC TR-CU 020/2011.....	EN 61326-1

**Marine:**

Det Norske Veritas, Ships & Offshore ..... Stand. f. Certific. No. 2.4

**I.S. / Ex:**

ATEX 94/9/EC.....	KEMA 07ATEX0148 X
IECEX.....	IECEX KEM 09.0052X
c FM us.....	3038279-C
INMETRO.....	NCC 12.1310 X
CCOE.....	P337349/3
EAC Ex TR-CU 012/2011 .....	RU C-DK.GB08.V.00410

**Functional Safety:**

SIL2 Certified & Fully Assessed acc. to IEC 61508

## Configuration of sensor error check

Sensor error check:		
Device:	Configuration	Sensor error detection:
9113	OUT.ERR=NONE.	OFF
	Else:	ON

## Visualisation in the 4501 of:

### Input signal outside range

Outside range readout (IN.LO, IN.HI): If the valid range of the A/D converter or the polynomial is exceeded			
Input	Range	Readout	Limit
CURR	0...20 mA / 4...20 mA	IN.LO	< -1.05 mA
		IN.HI	> 25.05 mA
TEMP	TC / RTD	IN.LO	< temperature range -2°C
		IN.HI	> temperature range +2°C

Display readout below min. / above max. (-1999, 9999):			
Input	Range	Readout	Limit
All	All	-1999	Display readout < -1999
		9999	Display readout > 9999

### Sensor error detection

Sensor error detection (SE.BR, SE.SH):			
Input	Range	Readout	Limit
CURR	Loop break (4...20 mA)	SE.BR	<= 3.6 mA; > = 20.75 mA
		SE.SH	> 10 kΩ...165 kΩ
TEMP	TC	SE.BR	> 900...1000 Ω (cable > 50 Ω)
		SE.SH	< app. 15 Ω
	RTD: 2-, 3- and 4-wire For Pt10, Pt20, Pt50, Pt100, Pt200, Ni50 and Ni120	SE.BR	> 10...12 kΩ (cable > 50 Ω)
		SE.SH	< app. 15 Ω
RTD: 2-, 3- and 4-wire for Pt250, Pt300, Pt400, Pt500, Pt1000 and Ni1000	SE.BR	> 10...12 kΩ (cable > 50 Ω)	
	SE.SH	< app. 15 Ω	

### Error indications

Readout at hardware error		
Error search	Readout	Cause
Input underrange	IN.LO	See conditions above
Input overrange	IN.HI	See conditions above
Sensor wire breakage	SE.BR	See conditions above
Sensor short circuit	SE.SH	See conditions above
Test of internal CJC sensor	CJ.ER	Internal CJC sensor defect or CJC temperature out of range**
CJC connector error - check CJC-connector block	CJ.CE	Defect or missing CJC-connector, temperature out of allowed range



Readout at hardware error		
Error search	Readout	Cause
Input error - check input connection and reset power	IN.ER	Signal levels on input beyond limits or connected to wrong terminals*
Output error - check output connections and reset power	AO.ER	Error in analogue output current (SIL mode only)*
No communication	NO.CO	No communication with (4501)
Flash memory error - check configuration	FL.ER CO.ER	FLASH error (configuration invalid)***
Invalid configuration type or version	TY.ER	Configuration read from EEprom has invalid type or rev. no.
Hardware error	RA.ER	RAM error*
Hardware error	IF.ER	Internal Flash error*
Hardware error	SW.ER	SW monitor error*
Hardware error	AD.ER	A/D converter error*
Hardware error	AO.SU	Analogue output supply error*
Hardware error	CA.ER	Factory calibration error*
Hardware error	CM.ER	Main CPU error*
Hardware error	II.ER	Initialisation check error*
Hardware error	RS.ER	Reset error*
Hardware error	IC.ER	Input communication error*
Hardware error	M1.ER	Main CPU to Ch.1 error*
Hardware error	M2.ER	Main CPU to Ch.2 error*
Hardware error	MC.ER	Main CPU config. error*
Hardware error	MF.ER	Main CPU Flash error*
Hardware error	MR.ER	Main CPU RAM error*
Hardware error	MS.ER	Main CPU supply error*
Hardware error	MP.ER	Main CPU ProgFlow error*

! All error indications in the display flash once per second. The help text explains the error.

\* Error is acknowledged by either stepping through the basic setup, or by resetting the device power. Some types of errors can only be acknowledged by resetting the device power.

\*\* Error is acknowledged by either stepping through the basic setup, or by resetting the device power. Error can be disregarded by selecting input type different than TC.

\*\*\* Error is acknowledged by stepping through the basic setup.

# CONNECTIONS

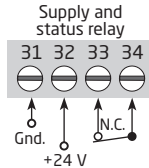
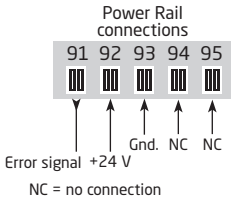

## Inputs

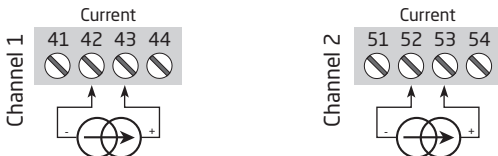
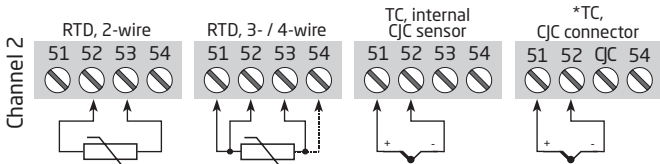
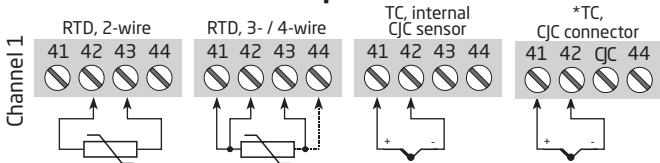

\* Order separately:  
CJC connector  
5910Ex (ch. 1) /  
5913Ex (ch. 2).

## Outputs

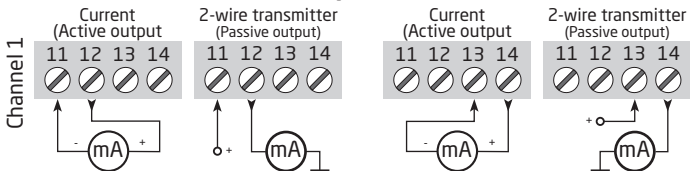

# BLOCK DIAGRAM

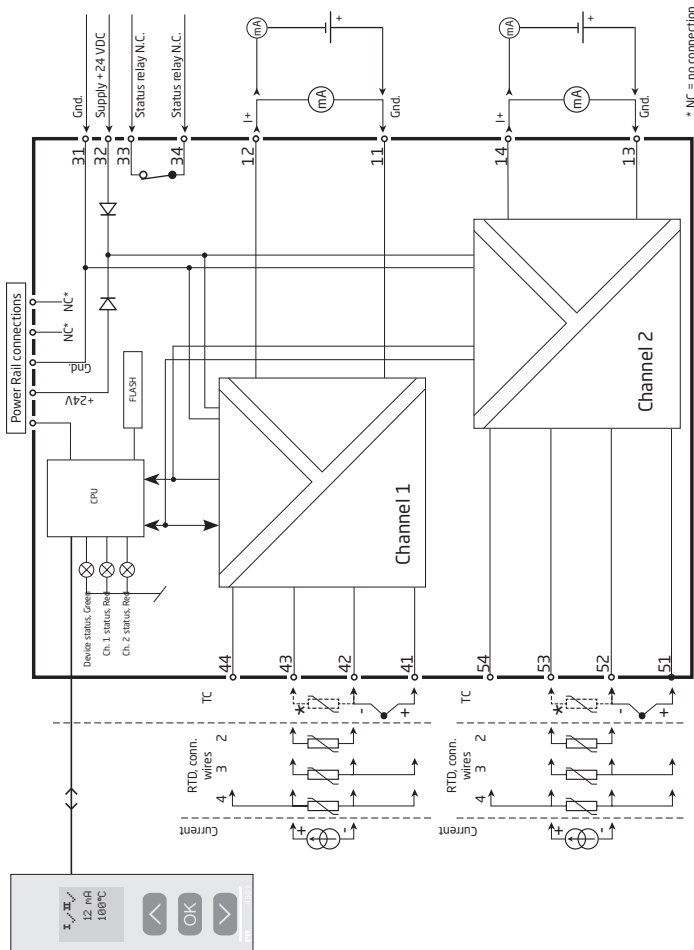

# 9113

## Signal error and cable fault indications without display front

List of LED and error signal indications						
Condition	Green LED	Ch. 1: Red LED	Ch. 2: Red LED	Status relay, N.C.	Power rail signal status	
Device OK	Flashing	OFF	OFF	Energized	Open	
No supply	OFF	OFF	OFF	De-energized	Closed	
Device defective	OFF	ON	ON	De-energized	Closed	
Ch. 1 defective (ch. 2 OK)	Flashing	ON	OFF	De-energized	Closed	
Ch. 2 defective (ch. 1 OK)	Flashing	OFF	ON	De-energized	Closed	
Channel 1, signal OK	Flashing	OFF	OFF	Energized	Open	
Ch. 1, wire short / break	Flashing	Flashing	OFF	De-energized	Closed (if activated)	
Channel 2, signal OK	Flashing	OFF	OFF	Energized	Open	
Ch. 2, wire short / break	Flashing	OFF	Flashing	De-energized	Closed (if activated)	

# CONFIGURATION / OPERATING THE FUNCTION KEYS

Documentation for routing diagram.

## In general

When configuring the 9113, you will be guided through all parameters and you can choose the settings which fit the application. For each menu there is a scrolling help text which is automatically shown in line 3 on the display.

Configuration is carried out by use of the 3 function keys:

- ⬆ will increase the numerical value or choose the next parameter
- ⬇ will decrease the numerical value or choose the previous parameter
- OK will accept the chosen value and proceed to the next menu

When configuration is completed, the display will return to the default state 1.0.

Pressing and holding OK will return to the previous menu or return to the default state (1.0) without saving the changed values or parameters.

If no key is activated for 1 minute, the display will return to the default state (1.0) without saving the changed values or parameters.

## Further explanations

**Password protection:** Programming access can be blocked by assigning a password. The password is saved in the converter in order to ensure a high degree of protection against unauthorised modifications to the configuration. Default password 2008 allows access to all configuration menus.

## Selection of units

By selection of temperature input you can choose which process units should be shown in the display (see table). The process value is always displayed in Celsius or Fahrenheit. This is selected in the menu point after selection of temperature input.

## CJC

In the CJC menu you can choose between CJC connector and internal cold junction compensation. The CJC connector (PR 5910Ex/PR 5913Ex) must be ordered separately.

## Signal and sensor error information via display front 4501

Sensor error (see limits in the table) is displayed as SE.BR (sensor break) or SE.SH (sensor short). Signals outside the selected range (not sensor error, see table for limits) are displayed as IN.LO indicating low input signal or IN.HI indicating high input signal. The error indication is displayed as text in line 2 for channel 1 and line 3 for channel 2 and at the same time the backlight flashes. Line 4 of the display is a status line which shows whether the device is SIL-locked (static dot = SIL-locked and flashing dot = not SIL-locked) as well as status for communication COM (running circle) indicating correct functioning of 4501.

## Signal and sensor error indication without display front

Status of the unit can also be read from the 3 LEDs in the front of the device.

Green flashing LED indicates normal operation.

No light in the green LED indicates lack of supply voltage or error in the device.

Steady red LED indicates fatal error.

Flashing red LED indicates sensor error.

## Advanced functions

The unit gives access to a number of advanced functions which can be reached by answering "YES" to the point "ADV.SET".

**Display setup:** Here you can adjust the brightness contrast and the backlight.

Setup of TAG numbers with 5 alphanumeric. Selection of functional readout in line 2 and 3 of the display - choose between readout of analogue input, analogue output or tag no or alternating display.

**Two-point process calibration:** The device can be process-calibrated in 2 points to fit a given input signal. A low input signal (not necessarily 0%) is applied and the actual value is entered. Then a high signal (not necessarily 100%) is applied and the actual value is entered. If you accept to use the calibration, the device will work according to this new adjustment. If you later reject this menu point or choose another type of input signal the device will return to factory calibration.

**Process simulation function:** In the menu point "EN.SIM" it is possible to simulate an input signal by means of the arrow keys and thus control the output signal up or down. You must exit the menu by pressing  (no time-out). The simulation function exits automatically, if the 4501 is detached.

**Password:** Here you can choose a pass word between 0000 and 9999 in order to protect the device against unauthorised modifications to the configuration. The device is delivered default without password.

**Language:** In the menu "lang.setup" you can choose between 7 different language versions of help texts that will appear in the menu. You can choose between UK, DE, FR, IT, ES, SE and DK.

**Power rail:** In the menu "RAIL" you can choose if sensor errors are transmitted to the central surveillance in the PR 9410 power control unit.

**Safety integrity level:** See Safety Manual for details.



# ROUTING DIAGRAM

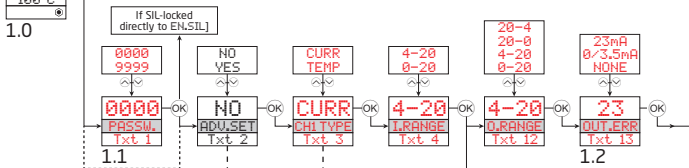
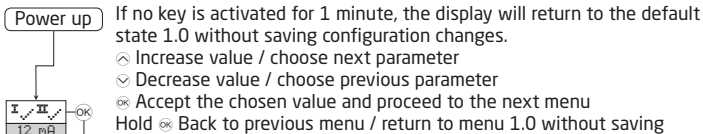

1.0 = Default state. Line 1 shows input status, line 2 and 3 show analogue input / output value or TAG No. and units, and line 4 shows status for communication and whether the device is SIL-locked. Static dot = SIL-locked and flashing dot = not SIL-locked.

1.1 = Only if password-protected.

1.2 = Not valid for 0...20 mA input signal.

1.3 = Only if input signal is temperature.

Min. and max. acc. to selected sensor type.

1.4 = Only if the configuration is not protected by a password.

Red text signifies safety parameters in a SIL configuration. See safety manual for details

Continued on the page  
Routing diagram ADV.SET

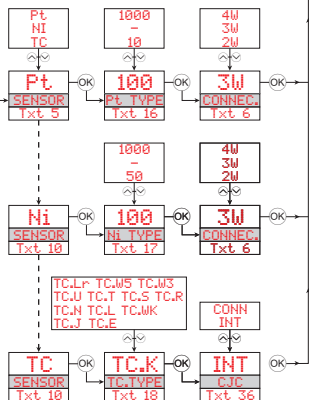



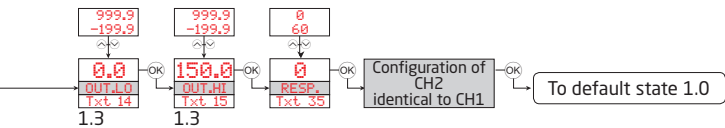

## ROUTING DIAGRAM, ADVANCED SETTINGS (ADV.SET)

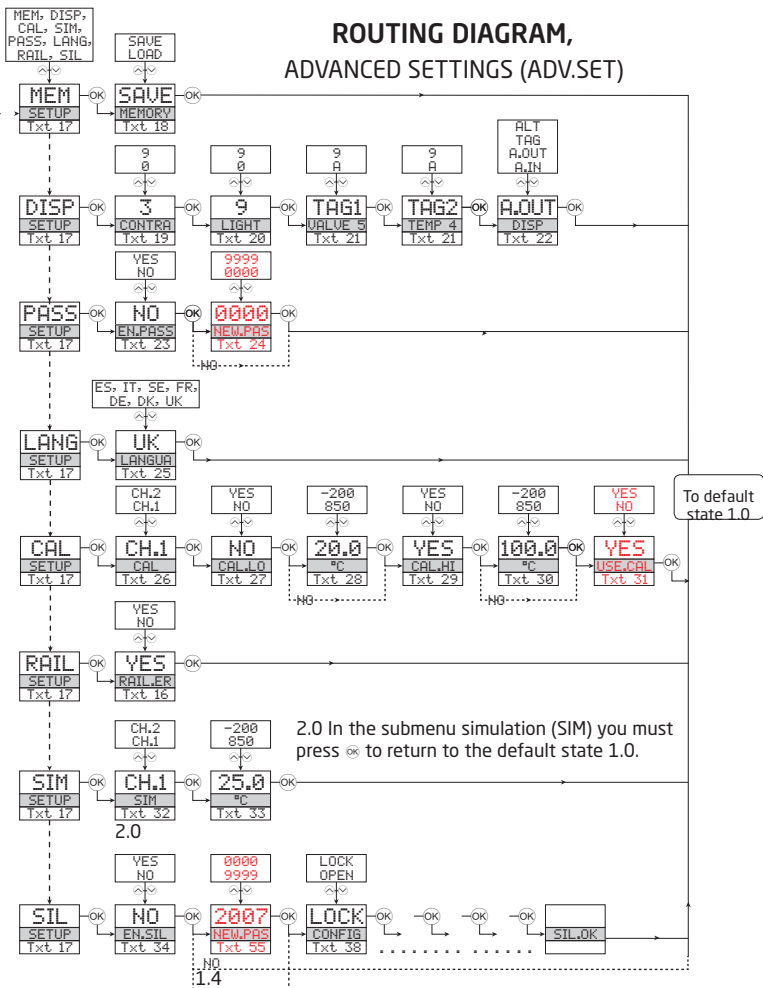

## SCROLLING HELP TEXTS IN DISPLAY LINE 3

- [01] Set correct password
- [02] Enter advanced setup menu?
- [03] Select temperature input  
Select current input
- [04] Select 0-20 mA input range  
Select 4-20 mA input range
- [05] Select TC sensor type  
Select Ni sensor type  
Select Pt sensor type
- [06] Select Pt10 sensor type  
Select Pt20 sensor type  
Select Pt50 sensor type  
Select Pt100 sensor type  
Select Pt200 sensor type  
Select Pt250 sensor type  
Select Pt300 sensor type  
Select Pt400 sensor type  
Select Pt500 sensor type  
Select Pt1000 sensor type
- [07] Select Ni50 sensor type  
Select Ni100 sensor type  
Select Ni120 sensor type  
Select Ni1000 sensor type
- [08] Select TC-B sensor type  
Select TC-E sensor type  
Select TC-J sensor type  
Select TC-K sensor type  
Select TC-L sensor type  
Select TC-N sensor type  
Select TC-R sensor type  
Select TC-S sensor type  
Select TC-T sensor type  
Select TC-U sensor type  
Select TC-W3 sensor type  
Select TC-W5 sensor type  
Select TC-Lr sensor type
- [09] Select 2-wire sensor connection  
Select 3-wire sensor connection  
Select 4-wire sensor connection
- [11] Select Celsius as temperature unit  
Select Fahrenheit as temperature unit
- [12] Select 0-20 mA output range  
Select 4-20 mA output range  
Select 20-0 mA output range  
Select 20-4 mA output range
- [13] Select no error action - output undefined at error  
Select downscale at error  
Select NAMUR NE43 downscale at error  
Select NAMUR NE43 upscale at error
- [14] Set temperature for analogue output low
- [15] Set temperature for analogue output high
- [16] Enable Rail status signal output?
- [17] Enter SIL setup  
Enter simulation mode  
Enter RAIL setup  
Perform process calibration  
Enter language setup  
Enter password setup  
Enter display setup  
Perform memory operations
- [18] Load saved configuration into 9113  
Save 9113 configuration in 4501
- [19] Adjust LCD contrast
- [20] Adjust LCD backlight
- [21] Write a 5-character channel TAG
- [22] Show analogue input value in display  
Show analogue output value in display  
Show TAG in display  
Alternate shown information in display
- [23] Enable password protection?
- [24] Set new password
- [25] Select language
- [26] Select channel to calibrate
- [27] Calibrate input low to process value?
- [28] Set value for low calibration point
- [29] Calibrate input high to process value?
- [30] Set value for high calibration point
- [31] Use process calibration values?
- [32] Select channel to simulate
- [33] Set the input simulation value
- [34] Enable SIL configuration lock?  
0-20 mA is not a valid output range for SIL operation
- [35] Set Analog output response time in seconds
- [36] Select internal temperature sensor  
Select CJC connector (accessory)
- [37] ...is channel using process-compensated calibration data?
- [38] Configuration SIL status (Open / Locked)
- [40] Sensor wire breakage
- [41] Sensor short circuit
- [42] Input underrange
- [43] Input overrange
- [44] Input error - check input connections and reset power
- [45] Output error - check connections and reset power
- [46] Flash memory error - check configuration
- [47] Invalid configuration type or version
- [48] Hardware error
- [49] CJC sensor error - check device temperature
- [50] CJC error - check CJC connector block
- [51] No communication

# APPENDIX

**IECEX Installation drawing**  
**ATEX Installation drawing**  
**FM Installation drawing**  
**INMETRO Installation drawing**  
**Safety manual**

## IECEx Installation drawing

**9113**

For safe installation of 9113B the following must be observed. The module shall only be installed by qualified personnel who are familiar with the national and international laws, directives and standards that apply to this area.

Year of manufacture can be taken from the first two digits in the serial number.

**4501**

For Installation in Zone 2 the following must be observed.

The 4501 programming module is to be used solely with PRelectronics modules. It is important that the module is undamaged and has not been altered or modified in any way. Only 4501 modules free of dust and moisture shall be installed.

IECEx Certificate: .....KEM 09.0052 X

Marking

[Ex ia Ga] IIC/IB/IIA

Ex nA nC IIC T4 Gc

[Ex ia Da] IIIC

[Ex ia Ma] I

Standards

IEC60079-15:2005, IEC60079-11:2011, IEC60079-0:2011

IEC60079-26:2006

Hazardous area  
Zone 0,1,2, 20, 21, 22

Non Hazardous area  
or Zone 2

$-20 \leq T_a \leq +60^{\circ}\text{C}$

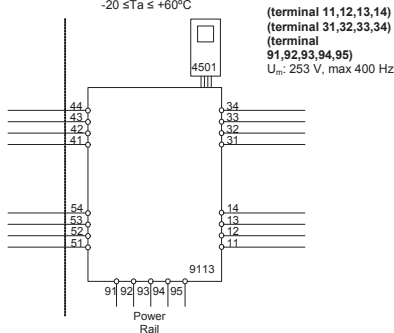

LERBAKKEN 10, 8410 RØNDE DENMARK

**Ex input**
**CH1 (terminal 41,42,43,44)**
**CH2 (terminal 51,52,53,54)**

$U_o$ : 8.7 V  
 $I_o$ : 18.4 mA  
 $P_o$ : 40 mW  
 $L_o/R_o$ : 892  $\mu\text{H}/\Omega$

	IIC	IIB	IIA or I
$C_o$	5 $\mu\text{F}$	50 $\mu\text{F}$	1000 $\mu\text{F}$
$L_o$	100 mH	300 mH	700 mH

$U_i$ : 10 V  
 $I_i$ : 30 mA  
 $C_i$ : 30 nF  
 $L_i$ : 820 nH

**Status Relay. terminal (33,34)**

Voltage max: 125 VAC / 110 VDC  
 Power max: 62.5 VA / 32 W  
 Current max: 0.5 A AC / 0.3 ADC

**Zone 2 installation:**

Voltage max: 32 VAC / 32 VDC  
 Power max: 16 VA / 32 W  
 Current max: 0.5 A AC / 1 ADC

**Installation notes:**

Install in pollution degree 2, overvoltage category II as defined in IEC60664-1

Do not separate connectors when energized and an explosive gas mixture is present.

Do not mount or remove modules from the Power Rail when an explosive gas mixture is present.

Disconnect power before servicing.

The wiring of unused terminals is not allowed.

In type of protection [Ex ia Da] the parameters for intrinsic safety for gas group IIB are applicable.

For installation in Zone 2, the module shall be installed in an enclosure in type of protection Ex n or Ex e, providing a degree of protection of at least IP54. Cable entry devices and blanking elements shall fulfill the same requirements.

For installation on Power Rail in Zone 2, only Power Rail type 9400 supplied by Power Control Unit type 9410 (Type Examination Certificate KEMA 07ATEX0152 X) is allowed.

LERBAKKEN 10, 8410 RØNDE DENMARK

Hazardous area  
Zone 0,1,2, 20, 21, 22

Non Hazardous area  
or Zone 2

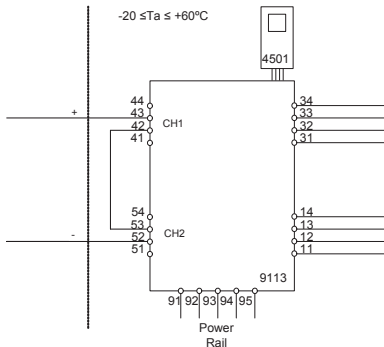

**Ex input**

**CH1 (terminal 43 +)**

**CH2 (terminal 52 -)**

$U_o$ : 17.4 V

$I_o$ : 18.4 mA

$P_o$ : 80 mW

$L_o/R_o$ : 445  $\mu$ H/ $\Omega$

(terminal 11,12,13,14)

(terminal 31,32,33,34)

(terminal

**91,92,93,94,95)**

$U_m$ : 253 V, max 400 Hz

	IIC	IIB	IIA
$C_o$	0.3 $\mu$ F	1.6 $\mu$ F	8 $\mu$ F
$L_o$	80 mH	250 mH	600 mH

$U_i$ : 10 V

$I_i$ : 30 mA

$C_i$ : 15 nF

$L_i$ : 1.7  $\mu$ H

LERBAKKEN 10, 8410 RØNDE DENMARK

## ATEX Installation drawing

**9113**

For safe installation of 9113B the following must be observed. The module shall only be installed by qualified personnel who are familiar with the national and international laws, directives and standards that apply to this area.

Year of manufacture can be taken from the first two digits in the serial number.

**4501**

For Installation in Zone 2 the following must be observed.

The 4501 programming module is to be used solely with PR electronics modules. It is important that the module is undamaged and has not been altered or modified in any way. Only 4501 modules free of dust and moisture shall be installed.

ATEX Certificate: .....KEMA 07ATEX 0148 X

Marking:.....



II (1) G [Ex ia Ga] IIC/IIB/IIA  
 II 3 G Ex nA nC IIC T4 Gc  
 II (1) D [Ex ia Da] IIIC  
 I (M1) [Ex ia Ma] I

Standards EN 60079-0 : 2009, EN 60079-11 : 2012, EN 60079-15 : 2005  
 EN 60079-26 : 2007

Hazardous area  
 Zone 0,1,2, 20, 21, 22

Non Hazardous area  
 or Zone 2  
 $-20 \leq T_a \leq +60^{\circ}\text{C}$

(terminal 11,12,13,14)  
 (terminal 31,32,33,34)  
 (terminal 91,92,93,94,95)  
 $U_m: 253\text{ V, max }400\text{ Hz}$

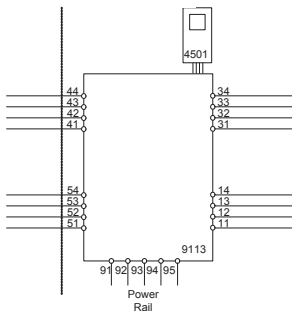

Revision date:  
 2012-07-04

Version Revision:  
 V4 R0

Prepared by:  
 PB

Page:  
 1/3



LERBAKKEN 10, 8410 RØNDE DENMARK

**Ex input**
**CH1 (terminal 41,42,43,44)**
**CH2 (terminal 51,52,53,54)**
 $U_o:$  8.7 V

 $I_o:$  18.4 mA

 $P_o:$  40 mW

 $L_o/R_o$  892  $\mu$ H/ $\Omega$ 

	IIC	IIB	IIA or I
$C_o$	5 $\mu$ F	50 $\mu$ F	1000 $\mu$ F
$L_o$	100 mH	300 mH	700 mH

 $U_i:$  10 V

 $I_i:$  30 mA

 $C_i:$  30 nF

 $L_i:$  820 nH

**Status Relay. terminal (33,34)**

Voltage max: 125 VAC / 110 VDC

Power max: 62.5VA / 32 W

Current max: 0.5 A AC / 0.3 ADC

Zone 2 installation:

Voltage max: 32 VAC / 32 VDC

Power max: 16 VA / 32 W

Current max: 0.5 A AC / 1 ADC

**Installation notes:**

Install in pollution degree 2, overvoltage category II as defined in EN60664-1

Do not separate connectors when energized and an explosive gas mixture is present.

Do not mount or remove modules from the Power Rail when an explosive gas mixture is present.

Disconnect power before servicing.

The wiring of unused terminals is not allowed.

In type of protection [Ex ia Da] the parameters for intrinsic safety for gas group IIB are applicable.

For installation in Zone 2, the module shall be installed in an enclosure in type of protection Ex n or Ex e, providing a degree of protection of at least IP54. Cable entry devices and blanking elements shall fulfill the same requirements.

For installation on Power Rail in Zone 2, only Power Rail type 9400 supplied by Power Control Unit type 9410 (Type Examination Certificate KEMA 07ATEX0152 X) is allowed.

 Revision date:  
2012-07-04

 Version Revision:  
V4 R0

 Prepared by:  
PB

 Page:  
2/3

LERBAKKEN 10, 8410 RØNDE DENMARK

 Hazardous area  
 Zone 0,1,2, 20, 21, 22

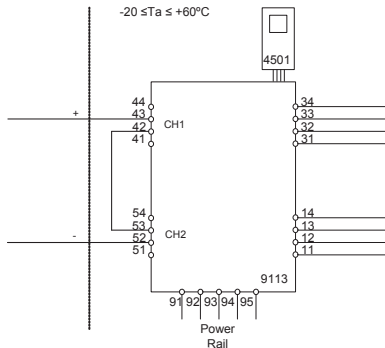
 Non Hazardous area  
 or Zone 2  
 $-20 \leq T_a \leq +60^\circ\text{C}$ 

**Ex input**
**CH1 (terminal 43)**
**CH2 (terminal 52)**
 $U_o:$  17,4 V

 $I_o:$  18,4 mA

 $P_o:$  80 mW

 $L_o/R_o$  445  $\mu\text{H}/\Omega$ 
**(terminal 11,12,13,14)**
**(terminal 31,32,33,34)**
**(terminal 91,92,93,94,95)**
 $U_m:$  253 V, max 400 Hz

	IIC	IIB	IIA or I
$C_o$	0,3 $\mu\text{F}$	1,6 $\mu\text{F}$	8 $\mu\text{F}$
$L_o$	80 mH	250 mH	600 mH

 $U_i:$  10 V

 $I_i:$  30 mA

 $C_i:$  15 nF

 $L_i:$  1,7  $\mu\text{H}$ 

 Revision date:  
 2012-07-04

 Version Revision:  
 V4 R0

 Prepared by:  
 PB

 Page:  
 3/3

## FM Installation drawing

**9113**

For safe installation of 9113B the following must be observed. The module shall only be installed by qualified personnel who are familiar with the national and international laws, directives and standards that apply to this area.

Year of manufacture can be taken from the first two digits in the serial number.

**4501**

For Installation in Zone 2 / Division 2 the following must be observed.

The 4501 programming module is to be used solely with PRelectronics modules. It is important that the module is undamaged and has not been altered or modified in any way. Only 4501 modules free of dust and moisture shall be installed.

c-FM-us Certificate: .....3038279

**Hazardous Classified Location**

Class I/II/III, Division 1, Group A,B,C,D,E,F,G  
or Class I, Zone 0/1 Group IIC, [AEx ia] IIC  
or Class I, Zone 0/1 Group IIC, [Ex ia] IIC

**Unclassified Location or  
Hazardous Classified Location**

Class I, Division 2, Group A,B,C,D T4  
or Class I, Zone 2 Group IIC T4

Intrinsically safe apparatus  
entity parameters:

$$V_{max}(U_i) \geq V_t(U_o)$$

$$I_{max}(I_i) \geq I_t(I_o)$$

$$P_i \geq P_o$$

$$C_a \geq C_{cable} + C_i$$

$$L_a \geq L_{cable} + L_i$$

The sum of capacitance and inductance of cable and intrinsic safe equipment must be less or equal to  $C_a$  and  $L_a$

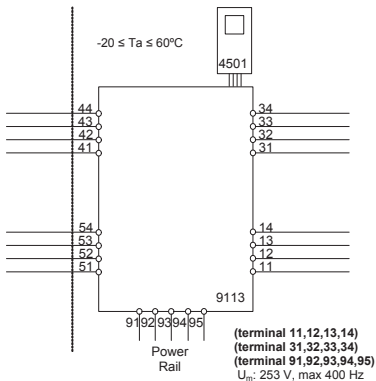

LERBAKKEN 10, 8410 RØNDE DENMARK

**Ex input**
**CH1 (terminal 41,42,43,44)**
**CH2 (terminal 51,52,53,54)**

 Vt (U<sub>o</sub>): 8.7 V

 It (I<sub>o</sub>): 18.4 mA

 P<sub>o</sub>: 40 mW

Lo/Ro 892 μH/Ω

	IIC / Group A,B	IIB / Group C,E,F	IIA / Group D,G
C <sub>a</sub> / C <sub>o</sub>	5 μF	50 μF	1000 μF
L <sub>s</sub> / L <sub>o</sub>	100 mH	300 mH	700 mH

 U<sub>i</sub>: 10 V

 I<sub>i</sub>: 30 mA

 C<sub>i</sub>: 30 nF

 L<sub>i</sub>: 820 nH

**Status Relay. terminal (33,34)**

Voltage max: 125 VAC / 110 VDC

Power max: 62.5 VA / 32 W

Current max: 0.5 A AC / 0.3 ADC

Zone 2 installation:

Voltage max: 32 VAC / 32 VDC

Power max: 16 VA / 32 W

Current max: 0.5 A AC / 1 ADC

**Installation notes:**

The installation and wiring shall be in accordance with the Canadian Electrical Code for Canada and National Electrical Code NFPA 70, Article 500 or 505 for installation in USA.

The module must be supplied from a Power Supply having double or reinforced insulation.

The use of stranded wires is not permitted for mains wiring except when wires are fitted with cable ends.

For installation on the 9400 Power Rail the power must be supplied from Power Control Module Unit 9410.

Install in pollution degree 2, overvoltage category II.

The module must be installed in an enclosure suitable for the environment for which it is used.

For installation in Zone 2 or Division 2, the module must be installed in a suitable outer enclosure according to the regulations in the CEC for Canada or NEC for USA.

The module is galvanic isolated and does not require grounding.

Use 60 / 75 °C Copper Conductors with wire Size AWG: (26-14).

**Warning:** Substitution of components may impair intrinsic safety.

**Warning:** To prevent ignition of the explosive atmospheres, disconnect power before servicing and do not separate connectors when energized and an explosive gas mixture is present.

**Warning:** Do not mount or remove modules from the Power Rail when an explosive gas mixture is present.

LERBAKKEN 10, 8410 RØNDE DENMARK

**Hazardous Classified Location**

 Class I/II/III, Division 1, Group A,B,C,D,E,F,G  
 or Class I, Zone 0/1 Group IIC, [AEx ia] IIC  
 or Class I, Zone 0/1 Group IIC, [Ex ia] IIC

**Unclassified Location or**
**Hazardous Classified Location**

 Class I, Division 2, Group A,B,C,D T4  
 or Class I, Zone 2 Group IIC T4

 Intrinsically safe apparatus  
 entity parameters:

$$V_{\max}(U_i) \geq V_t(U_o)$$

$$I_{\max}(I_i) \geq I_t(I_o)$$

$$P_i \geq P_o$$

$$C_a \geq C_{\text{cable}} + C_i$$

$$L_a \geq L_{\text{cable}} + L_i$$

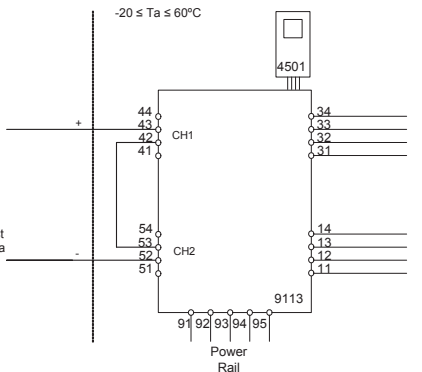
 The sum of capacitance and  
 inductance of cable and  
 intrinsic safe equipment must  
 be less or equal to  $C_a$  and  $L_a$ 

**Ex input**
**CH1 (terminal 42,43)**
**CH2 (terminal 52,53)**
 $V_t(U_o)$ : 17.4 V

 $I_t(I_o)$ : 18.4 mA

 $P_o$ : 80 mW

 $L_o/R_o$ : 445  $\mu\text{H}/\Omega$ 

 (terminal 11,12,13,14)  
 (terminal 31,32,33,34)  
 (terminal 91,92,93,94,95)  
 $U_m$ : 253 V, max 400 Hz

	IIC / Group A,B	IIB / Group C,E,F	IIA / Group D,G
$C_a / C_o$	0.3 $\mu\text{F}$	1.6 $\mu\text{F}$	8 $\mu\text{F}$
$L_a / L_o$	80 mH	250 mH	600 mH

 $U_i$ : 10 V  
 $I_i$ : 30 mA  
 $C_i$ : 15 nF  
 $L_i$ : 1.7  $\mu\text{H}$ 

 Revision date:  
 2012-06-07

 Version Revision:  
 V4 R0

 Prepared by:  
 PB

 Page:  
 3/3

## INMETRO Desenhos para Instalação



Para instalação segura do 9113B o manual seguinte deve ser observado. O módulo deve ser instalado somente por profissionais qualificados que estão familiarizados com as leis nacionais e internacionais, diretrizes e normas que se aplicam a esta área. Ano de fabricação pode ser obtido a partir dos dois primeiros dígitos do número de série.



### 4501

Para a instalação na Zona 2 o seguinte deve ser observado. O módulo de programação de 4501 deve ser utilizado apenas com os módulos PRelectronics. É importante que o módulo esteja intacto e não tenha sido alterado ou modificado de qualquer maneira. Apenas os módulos 4501 livres de poeira e umidade devem ser instalados.

### INMETRO Certificado ..... NCC 12.1310X

Marcas [Ex ia Ga] IIC/IIB/IIA  
Ex nA nC IIC T4 Gc  
[Ex ia Da] IIIC

Normas IEC60079-15:2005, IEC60079-11:2011, IEC60079-0:2011  
IEC60079-26:2006

Área de Risco  
Zona 0,1,2, 20, 21, 22

Área de não Risco  
ou Zona 2

$-20 \leq T_a \leq +60^{\circ}\text{C}$

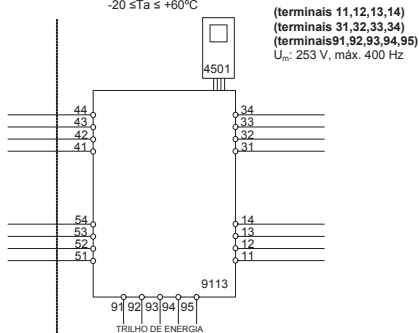

LERBAKKEN 10, 8410 RØNDE DENMARK

**Entrada Ex**
**CN1 (terminais 41,42,43,44)**
**CN2 (terminais 51,52,53,54)**
 $U_0$ : 8,7 V

 $I_0$ : 18.4 mA

 $P_0$ : 40 mW

 $L_0/R_0$  892  $\mu\text{H}/\Omega$ 

	IIC	IIB	IIA
$C_0$	5 $\mu\text{F}$	50 $\mu\text{F}$	1000 $\mu\text{F}$
$L_0$	100 mH	300 mH	700 mH

 $U_i$ : 10 V

 $I_i$ : 30 mA

 $C_i$ : 30 nF

 $L_i$ : 820 nH

**Relê de Estado terminais (33,34)**

Voltagem máx.: 125 VAC / 110 VDC

Potencia máx.: 62,5 VA / 32 W

Corrente máx.: 0,5 A AC / 0,3 ADC

**Instalação Zone 2:**

Voltagem máx.: 32 VAC / 32 VDC

Potência máx.: 16 VA / 32 W

Corrente máx.: 0,5 A AC / 1 ADC

**Notas de Instalação:**

Instalação em grau de poluição 2, categoria de sobretensão II conforme definido no IEC 60664-1  
 Não separe conectores quando energizado ou quando uma mistura de gás explosivo estiver presente.

Não monte ou remova módulos do trilho de alimentação quando uma mistura explosiva de gás estiver presente.

Desligue a alimentação antes da manutenção.

A fiação de terminais sem uso não é permitida.

A fonte de Loop e terminais de entrada de corrente para o mesmo canal não deve ser aplicada ao mesmo tempo.

Em tipo de proteção [Ex ia Da] os parâmetros para a segurança intrínseca para grupo de gás IIB são aplicáveis.

Para a instalação em Zona 2, o módulo deve ser instalado em um invólucro certificado conforme as normas da série ABNT NBR IEC 60079 que proporcione um grau de proteção de pelo menos IP54. Dispositivos de entrada de cabo e elementos de vedação devem cumprir com os mesmos requisitos.

Para a instalação de trilho de energia na Zona 2, apenas o trilho de alimentação Rail 9400 fornecido pela Unidade de Controle de Potência 9410 é permitido.

LERBAKKEN 10, 8410 RØNDE DENMARK

Área de Risco  
Zona 0,1,2, 20, 21, 22

Área de não Risco  
ou Zona 2

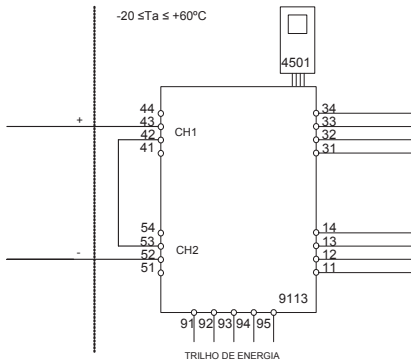

**Entrada Ex**

**CN1 (terminais 43 +)**

**CN2 (terminais 52 -)**

$U_o$ : 17.4 V

$I_o$ : 18,4 mA

$P_o$ : 80 mW

$L_o/R_o$ : 445  $\mu$ H/ $\Omega$

(terminais 11,12,13,14)

(terminais 31,32,33,34)

(terminais 91,92,93,94,95)

$U_m$ : 253 V, máx. 400 Hz

	IIC	IIB	IIA
$C_o$	0,3 $\mu$ F	1,6 $\mu$ F	8 $\mu$ F
$L_o$	80 mH	250 mH	600 mH

$U_i$ : 10 V

$I_i$ : 30 mA

$C_i$ : 15 nF

$L_i$ : 1,7  $\mu$ H



# **SAFETY MANUAL**

## **TEMPERATURE / mA CONVERTER 9113**

**This safety manual is valid for the following product versions:**

**9113-004**

**9113-003**

**9113-002**

**0 CONTENTS**

1	Observed standards.....	3
2	Acronyms and abbreviations .....	3
3	Purpose of the product.....	3
4	Assumptions and restrictions for use of the product .....	4
4.1	Basic safety specifications .....	4
4.2	Safety accuracy .....	4
4.2.1	Minimum span .....	4
4.2.2	Range limitations .....	4
4.3	Associated equipment.....	4
4.3.1	RTD sensor wiring .....	4
4.3.2	Sensor errors .....	5
4.3.3	Process calibration .....	5
4.3.4	Analogue output .....	5
4.4	Failure rates .....	5
4.5	Safe parameterisation.....	5
4.6	Installation in hazardous areas .....	5
5	Functional specification of the safety function.....	5
6	Functional specification of the non-safety functions.....	5
7	Safety parameters.....	6
8	Hardware and software configuration.....	6
9	Failure category.....	6
10	Periodic proof test procedure .....	7
11	Procedures to repair or replace the product.....	7
12	Maintenance.....	7
13	Documentation for routing diagram.....	7
13.1	In general .....	7
13.2	Further explanations .....	8
13.2.1	Password protection.....	8
13.2.2	Sensor/cable fault information via display front 4501.....	8
13.3	Advanced functions.....	8
13.3.1	Memory (MEM) .....	8
13.3.2	Display setup (DISP) .....	8
13.3.3	Password (PASS).....	8
13.3.4	Language (LANG).....	8
13.3.5	Process calibration (CAL) .....	9
13.3.6	Power rail (RAIL) .....	9
13.3.7	Simulation (SIM).....	9
13.3.8	Safety integrity level (SIL) .....	9
14	Safe parameterisation - user responsibility .....	10
14.1	Safety-related configuration parameters.....	10
14.1.1	Parameters related only to Channel 1 .....	10
14.1.2	Parameters related only to Channel 2 (only for type 9113BB) .....	13
14.1.3	Parameters related to both channels .....	13
14.2	Verification procedure.....	13
14.2.1	If no password is set .....	14
14.2.2	If password is set.....	17
14.2.3	If any parameter is found to be incorrect during verification .....	17
14.3	Functional test .....	17

15	Fault reaction and restart condition .....	17
16	User interface .....	18
16.1	Scrolling help texts in display line 3 .....	18
16.2	Routing diagram .....	19
16.3	Routing diagram - Advanced settings (ADV.SET).....	21
17	Connections diagram.....	22

## 1 Observed standards

Standard	Description
IEC 61508	Functional Safety of electrical / electronic / programmable electronic safety-related systems
IEC 61508-2:2000	Part 2: Requirements for electrical / electronic / programmable electronic safety-related systems
IEC 61508-3:1998	Part 3: Software requirements
IEC 61326-3-1:2008	Immunity requirements for safety-related systems

## 2 Acronyms and abbreviations

Acronym / Abbreviation	Designation	Description
Element		Term defined by IEC 61508 as “part of a subsystem comprising a single component or any group of components that performs one or more element safety functions”
PFD	Probability of Failure on Demand	This is the likelihood of dangerous safety function failures occurring on demand.
PFH	Probability of dangerous Failure per Hour	The term “Probability” is misleading, as IEC 61508 defines a Rate.
SFF	Safe Failure Fraction	Safe Failure Fraction summarises the fraction of failures which lead to a safe state and the fraction of failures which will be detected by diagnostic measures and lead to a defined safety action.
SIF	Safety Integrity Function	Function that provides fault detection (to ensure the necessary safety integrity for the safety functions)
SIL	Safety Integrity Level	The international standard IEC 61508 specifies four discrete safety integrity levels (SIL 1 to SIL 4). Each level corresponds to a specific probability range regarding the failure of a safety function.

## 3 Purpose of the product

Conversion and scaling of temperature (Pt, Ni and TC) and current signals from hazardous area.

The device can be mounted in the safe area and in zone 2 / div. 2 and receive signals from zone 0, 1, 2, 20, 21 and 22 / Class I/II/III, Div. 1, Gr. A-G.

Error events, including cable breakage, are monitored and signalled via the individual status relay and/or a collective electronic signal via the power rail.

The 9113 has been designed, developed and certified for use in SIL 2 applications according to the requirements of IEC 61508.

## 4 Assumptions and restrictions for use of the product

### 4.1 Basic safety specifications

Operational temperature range.....	-20...+60°C
Storage temperature range.....	-20...+85°C
Power supply type, min.....	Double or reinforced
Supply voltage .....	19.2...31.2 VDC
External loop supply voltage .....	5...26 VDC + external drop
Mounting area.....	Zone 2 / Division 2 or safe area
Mounting environment.....	Pollution degree 2 or better

### 4.2 Safety accuracy

The analogue output corresponds to the applied input within the safety accuracy.  
 Safety accuracy .....  $\pm 2\%$

#### 4.2.1 Minimum span

For temperature measurements, the selected range (OUT.HI - OUT.LO) shall be larger or equal to the values below:

Input type	Minimum span for safety accuracy
Pt100, Pt200, Pt1000	28°C
Pt500, Ni100, Ni120, Ni1000	43°C
Pt50, Pt400, Ni50	57°C
Pt250, Pt300	85°C
Pt20	142°C
Pt10	283°C
TC: E, J, K, L, N, T, U	91°C
TC: B, R, S, W3, W5, LR	153°C

#### 4.2.2 Range limitations

TC type B shall not be used below +400°C

### 4.3 Associated equipment

#### 4.3.1 RTD sensor wiring

If a 2-wire or a 3-wire connection for RTD is selected, the end user must ensure that the applied sensor wiring does not introduce failures exceeding the requirements for the safety application.

#### 4.3.2 Sensor errors

If Sensor error detection is disabled, if current input range 0...20 mA is selected or if input type Pt10, Pt20, or Pt50 is selected, the end user must ensure that the applied sensor including wiring has a failure rate qualifying it for the safety application without sensor error detection enabled.

For Pt10, Pt20 and Pt50 input types, this only relates to short-circuited sensor detection.

#### 4.3.3 Process calibration

If a process calibration is taken into SIL-mode operation, it is mandatory that the accuracy of the device (and sensor, if applicable) are tested by the end user after SIL-mode is entered, in addition to the normal functional test. Refer to section 14 - Safe parameterisation - user responsibility.

#### 4.3.4 Analogue output

The connected safety PLC shall be able to detect and handle the fault indications on the analogue output of the 9113 converter by having a NAMUR NE43-compliant current input.

#### 4.4 Failure rates

The basic failure rates from the Siemens standard SN 29500 are used as the failure rate database.

Failure rates are constant, wear-out mechanisms are not included.

External power supply failure rates are not included.

#### 4.5 Safe parameterisation

The user is responsible for verifying the correctness of the configuration parameters. (See section 14 Safe parameterisation - user responsibility).

Manual override may not be used for safety applications.

#### 4.6 Installation in hazardous areas

The IECEx Installation drawing, ATEX Installation drawing and FM Installation drawing shall be followed if the products are installed in hazardous areas.

### 5 Functional specification of the safety function

Conversion of current signals (0...20 mA or 4...20 mA), RTD sensor signals or thermocouple sensor signals from hazardous areas to a 4...20 mA current output signal, in two separately configurable channels, within specified accuracy.

For RTD sensors, cable resistances of up to 50  $\Omega$  per wire can be compensated if 3- or 4-wire connection is configured.

For thermocouple sensors, cold junction temperature errors can be compensated, either by an internally mounted temperature sensor, or by an accessory connector with a built-in temperature sensor. The selection of CJC measurement must be done and verified by the end user.

### 6 Functional specification of the non-safety functions

The status relay (terminal 33 and 34), error signal on power rail (terminal 91) and LED outputs are not suitable for use in any Safety Instrumented Function.

## 7 Safety parameters

Probability of dangerous Failure per Hour (PFH)	6.10E-08
	Note <sup>1</sup>
Probability of failure on demand (PFD) - 1 year proof test interval	3.96E-04
Proof test interval (10% of loop PFD)	3 years
Safe Failure Fraction	90.7 %
Demand response time	Signal input: < 0.5 seconds Temperature input: < 1.1 seconds
Demand mode	High
Demand rate	3000 seconds
Mean Time To Repair (MTTR)	24 hours
Diagnostic test interval	30 seconds
Hardware Fault Tolerance (HFT)	0
Component Type	B
SIL capability	SIL 2
Description of the "Safe State"	Output $\leq$ 3.6 mA or output $\geq$ 21 mA

Note1: The 9113 contains no lifetime limiting components, therefore the PFH figures are valid for up to 12 years, according to IEC 61508.

## 8 Hardware and software configuration

All configurations of software and hardware versions are fixed from factory, and cannot be changed by end-user or reseller.

This manual only covers products labelled with the product version (or range of versions) specified on the front page.

## 9 Failure category

Failure category	Failure rates (1/h)
Fail Safe Detected	0.000E-0
Fail Safe Undetected	2.34E-7
Fail Dangerous Detected	3.67E-7
Fail Dangerous Undetected	6.10E-8

## 10 Periodic proof test procedure

Step	Action
1	Bypass the safety PLC or take other appropriate action to avoid a false trip
2	Connect a simulator identical to the input setup
3	Apply input value corresponding to 0/100% output range to each channel
4	Observe whether the output channel acts as expected
5	Restore the input terminals to full operation
6	Remove the bypass from the safety PLC or otherwise restore normal operation

This test will detect approximately 95% of possible “du” (dangerous undetected) failures in the device. The proof test is equivalent to the functional test.

## 11 Procedures to repair or replace the product

Any failures that are detected and that compromise functional safety should be reported to the sales department at PR electronics A/S.

Repair of the device and replacement of circuit breakers must be done by PR electronics A/S only.

## 12 Maintenance

No maintenance required.

## 13 Documentation for routing diagram

The routing diagram is shown in section 16.2.

### 13.1 In general

When configuring the 9113, you will be guided through all parameters and you can choose the settings which fit the application. For each menu there is a scrolling help text which is automatically shown in line 3 on the display.

Configuration is carried out by use of the 3 function keys:

- ⏪ will increase the numerical value or choose the next parameter
- ⏩ will decrease the numerical value or choose the previous parameter
- ⏹ will accept the chosen value and proceed to the next menu

When configuration is completed, the display will return to the default state 1.0.

Pressing and holding ⏹ will return to the previous menu or return to the default state (1.0) without saving the changed values or parameters.

If no key is activated for 1 minute, the display will return to the default state (1.0) without saving the changed values or parameters.



## 13.2 Further explanations

### 13.2.1 Password protection

Access to the configuration can be blocked by assigning a password. The password is saved in the device in order to ensure a high degree of protection against unauthorised modifications to the configuration. Default password 2008 allows access to all configuration menus. Password protection is mandatory in SIL applications.

### 13.2.2 Sensor/cable fault information via display front 4501

When the function is enabled and supported by selected input type, sensor or cable faults are displayed as SE.BR (sensor break) or SE.SH (cable short-circuited). Sensor fault is shown independently for each channel.

In case of sensor or cable fault the backlight flashes. This can be reset by pressing the  key. When the sensor or cable fault has been remedied, the device will return to normal operation.

## 13.3 Advanced functions

The device gives access to a number of advanced functions which can be reached by answering "Yes" to the point "adv.set".

### 13.3.1 Memory (MEM)

In the memory menu a non-SIL configuration can be either saved or loaded from the local memory of the 4501 display unit. Choose SAVE to store the current configuration in the 4501 memory. Press LOAD to read a previously stored configuration in the 4501 memory and store it in the device. It is only possible to load a configuration stored from the same type of device and from the same version, or earlier.

### 13.3.2 Display setup (DISP)

The brightness contrast and the backlight can be adjusted.

Tag numbers with 5 alphanumeric can be entered for both channels.

Functional readout in line 2 (ch.1) and 3 (Ch.2) of the display can be selected: choose between readout of input value, output current or tag no. When selecting "ALT" the readout alternates between input value, output current and tag no.

### 13.3.3 Password (PASS)

Here you can choose a password between 0000 and 9999 in order to protect the device against unauthorised modifications to the configuration. The device is delivered default without password.

### 13.3.4 Language (LANG)

In this menu you can choose between 7 different language versions of help texts that will appear in the menu. You can choose between UK, DE, FR, IT, ES, SE and DK.

**13.3.5 Process calibration (CAL)**

A process calibration can be made by the end user. A known process signal must be applied for both low and high end of the input measurement range. The known input of the applied low end signal must be entered in the CAL.LO menu and confirmed by pressing OK before removing or changing the applied signal to the high end signal. The known input of the applied high end signal must be entered in the CAL.HI menu and confirmed by pressing OK before removing. It is possible to enable or disable the use of the latest process calibration.

**13.3.6 Power rail (RAIL)**

In this menu it can be chosen if errors in the device are transmitted to the central surveillance in the PR 9410 power control device.

**13.3.7 Simulation (SIM)**

It is possible to override the actual measured input signal by a simulated value. Only one channel can be simulated at a time. Leaving either of the simulation menus, or disconnecting the 4501 device, will disable the simulation mode and bring the output back to correspond to the actual measured value. Simulation is not possible in SIL-mode.

**13.3.8 Safety integrity level (SIL)**

See section 14 - Safe parameterisation - user responsibility

## 14 Safe parameterisation - user responsibility

### 14.1 Safety-related configuration parameters

#### 14.1.1 Parameters related only to Channel 1

Name	Function
CH1.TYP	Selected input type: TEMP = Temperature CURR = Current
I.RANGE	Selected fixed input range for current measurements (for CH1.TYP = CURR): 0_20 = 0...20 mA (no sensor error detection!) 4_20 = 4...20 mA
CONNEC	Selected sensor connection type for RTD measurements (for SENSOR = Ni or Pt): 2W = 2-wire 3W = 3-wire 4W = 4-wire  If 2W or 3W is selected, the end user must ensure that the applied sensor wiring does not introduce failures exceeding the requirements for the safety application.
UNIT	Selected temperature unit (for CH1.TYP = TEMP): °C = degrees Celsius °F = degrees Fahrenheit
SENSOR	Selected temperature sensor type (for CH1.TYP = TEMP): TC = Thermocouple Ni = Ni RTD sensor Pt = Pt RTD sensor
Pt.TYPE	Pt sensor type (for SENSOR = Pt): 10 = Pt10 20 = Pt20 50 = Pt50 100 = Pt100 200 = Pt200 250 = Pt250 300 = Pt300 400 = Pt400 500 = Pt500 1000 = Pt1000  (No short circuit detection!)

Name	Function
Ni.TYPE	Ni sensor type (for SENSOR = Ni): 50 = Ni50 100 = Ni100 120 = Ni120 1000 = Ni1000
TC.TYPE	Thermocouple type (for SENSOR = TC): TC.B = Thermocouple type B TC.E = Thermocouple type E TC.J = Thermocouple type J TC.K = Thermocouple type K TC.L = Thermocouple type L TC.N = Thermocouple type N TC.R = Thermocouple type R TC.S = Thermocouple type S TC.T = Thermocouple type T TC.U = Thermocouple type U TC.W3 = Thermocouple type W3 TC.W5 = Thermocouple type W5 TC.Lr = Thermocouple type Lr
CJC	CJC type for SENSOR = TC: INT = Internal CJC sensor measurement CONN = CJC connector measurement (accessory)
O.RANGE	Fixed output range for current output: 0-20 = 0...20 mA Not valid when EN.SIL = YES (Safety applications) 4-20 = 4...20 mA 20-0 = 20...0 mA Not valid when EN.SIL = YES (Safety applications) 20-4 = 20...4 mA

Name	Function
OUT.ERR	<p>Fixed output value on detected sensor error:            NONE = Sensor error detection NOT enabled, output at sensor error is undefined.</p> <p>The end user must ensure that the applied sensor including wiring has a failure rate qualifying it for the safety application without the detection enabled.</p> <p>0 mA = Output is 0 mA at sensor error            3.5 mA = Output is 3.5 mA at sensor error (NE43 downscale)            23 mA = Output is 23 mA at sensor error (NE4 upscale)</p>
OUT.LO	<p>Selected temperature value for 0% output for CH1.TYP = TEMP in units defined by the UNIT parameter (°C or °F)</p> <p>Range is defined by the selected temperature sensor (SENSOR and TC.TYPE, Ni.TYPE or Pt.TYPE), but value must be less than OUT.HI - minimum span.</p>
OUT.HI	<p>Selected temperature value for 100% output for CH1.TYP = TEMP in units defined by the UNIT parameter (°C or °F).</p> <p>Range is defined by the selected temperature sensor (SENSOR and TC.TYPE, Ni.TYPE or Pt.TYPE), but must be larger than OUT.LO + minimum span.</p>
RESP	<p>Analogue output response time in seconds.</p> <p>Range is 0.0 to 60.0 seconds.</p>
USE.CAL	<p>Use the applied process calibration values:</p> <p>NO = The last performed process calibration on Channel1 is not used. The channel operates with accuracy as specified.</p> <p>YES = The last performed process calibration on Channel1 is in operation. The required accuracy must be verified by user.</p> <p>End user must verify by test that the applied process calibration does not introduce failures exceeding the requirements for the safety application.</p>

**14.1.2 Parameters related only to Channel 2 (only for type 9113BB)**

Name	Function
CH1.TYP	Functions as described for Channel 1 (14.1.1)
I.RANGE	
CONNEC	
UNIT	
SENSOR	
Pt.TYPE	
Ni.TYPE	
TC.TYPE	
CJC	
O.RANGE	
OUT.ERR	
OUT.LO	
OUT.HI	
RESP	
USE.CAL	

**14.1.3. Parameters related to both channels**

Name	Function
NEW.PAS	Password for protection of the device configuration from un-authorized access. Range from 0 to 9999.

The above safety-related configuration parameters are marked in red text in the routing diagrams and must be verified by the user in a SIL configuration.

**14.2. Verification procedure**

The verification is done using the display / programming front PR 4501 and following the procedure described below.

## 14.2.1 If no password is set

	Action	Display shows
1	Press OK	ADV.SET
2	Set (ADV.SET) to Yes and press OK	SETUP
3	Set SETUP to SIL and press OK	EN.SIL
4	Set EN.SIL to YES and press OK	NEW.PAS
5	Set password to a number between 0 and 9999 and press OK (At this time the device starts operating in SIL mode with the entered configuration parameters!)	CONFIG Verify OPEN->LOCK*
6	Press OK to confirm verification of the OPEN->LOCK in the display	CH1.TYP
7	Verify input type for Channel 1 and press OK	I.RANGE
8	Verify fixed input range and press OK (ONLY IF CH1.TYP = CURR)	CONNEC
9	Verify sensor connection type and press OK (ONLY IF SENSOR = Ni or Pt and CH1.TYP = TEMP)	UNIT
10	Verify temperature unit and press OK (ONLY IF CH1.TYP = TEMP)	SENSOR
11	Verify temperature sensor type and press OK ( ONLY IF CH1.TYP = TEMP)	Pt.TYPE
12	Verify Pt sensor type and press OK (ONLY IF SENSOR = Pt and CH1.TYP = TEMP)	Ni.TYPE
13	Verify Ni sensor type and press OK (ONLY IF SENSOR = Ni and CH1.TYP = TEMP)	TC.TYPE
14	Verify Thermocouple type and press OK (ONLY IF SENSOR = TC and CH1.TYP = TEMP)	CJC

\* Open is shown briefly in the display.

	Action	Display shows
15	Verify CJC type and press OK (ONLY IF SENSOR = TC and CH1.TYP = TEMP)	O.RANGE
16	Verify fixed output range and press OK	OUT.ERR
17	Verify fixed output value on detected sensor error and press OK (ONLY IF CH1.TYP = TEMP, or IF I.RANGE = 4-20 mA)	OUT.LO
18	Verify temperature for 0% output and press OK (ONLY IF CH1.TYP = TEMP)	OUT.HI
19	Verify temperature for 100% output and press OK (ONLY IF CH1.TYP = TEMP)	RESP
20	Verify analogue output response time and press OK	CH2.TYP
21	Verify input type for Channel 2 and press OK	I.RANGE
22	Verify fixed input range and press OK (ONLY IF CH2.TYP = CURR)	CONNEC
23	Verify sensor connection type and press OK (ONLY IF SENSOR = Ni or Pt and CH2.TYP = TEMP)	UNIT
24	Verify temperature unit and press OK (ONLY IF CH2.TYP = TEMP)	SENSOR
25	Verify temperature sensor type and press OK ( ONLY IF CH2.TYP = TEMP)	Pt.TYPE
26	Verify Pt sensor type and press OK (ONLY IF SENSOR = Pt and CH2.TYP = TEMP)	Ni.TYPE



	Action	Display shows
27	Verify Ni sensor type and press OK (ONLY IF SENSOR = Ni and CH2.TYP = TEMP)	TC.TYPE
28	Verify Thermocouple type and press OK (ONLY IF SENSOR = TC and CH2.TYP = TEMP)	CJC
29	Verify CJC type and press OK (ONLY IF SENSOR = TC and CH2.TYP = TEMP)	O.RANGE
30	Verify fixed output range for current output	OUT.ERR
31	Verify fixed output value on detected sensor error and press OK (ONLY IF CH2.TYP = TEMP, or IF I.RANGE = 4-20 mA or 20-4 mA)	OUT.LO
32	Verify temperature for 0% output and press OK (ONLY IF CH2.TYP = TEMP)	OUT.HI
33	Verify temperature for 100% output and press OK (ONLY IF CH2.TYP = TEMP)	RESP
34	Verify analogue output response time and press OK	CH1.CAL
35	Verify the use of applied process calibration values for Channel 1 and press OK	CH2.CAL
36	Verify the use of applied process calibration values for Channel 2 and press OK	PASSW.
37	Verify password and press OK	SIL.OK
38	Verify SIL mode within 1 second	

**14.2.2 If password is set**

	Action	Display shows
1	Press OK	PASSW
2	Enter password and press OK	ADV.SET
3	Set ADV.SET to Yes and press OK	SETUP
4	Set SETUP to SIL and press OK	EN.SIL
5	Set EN.SIL to YES and press OK (At this time the device starts operating in SIL mode with the entered configuration parameters!)	CONFIG Verify OPEN->LOCK*
6 to 38	As step 6 to 38 for 14.2.1	As step 6 to 38 for 14.2.1

\* Open is shown briefly in the display

**14.2.3 If any parameter is found to be incorrect during verification**

Remove SIL-mode (by entering the password and selecting SIL-mode OFF).

Go through the setup menu and correct the parameter(s).

Repeat step 1 to 38 (with correct parameters).

**14.3 Functional test**

The user is responsible to make a functional test after verification of the safety parameters. The procedure for periodic proof test described in section 10 shall be used.

In addition, if a process calibration is taken into SIL-mode operation (refer to section 13.3 - Advanced functions), it is mandatory that the accuracy of the device (and sensor, if applicable) are tested.

**15 Fault reaction and restart condition**

When the 9113 detects a fault the output will go to Safe State, in which the output will go to “de-energised”.

If the fault is application-specific (cable error detection) the 9113 will restart when the fault has been corrected.

For device faults there are 2 ways of bringing the device out of Safe State.

1. Power cycle the device.
2. Bring the device out of SIL mode (choose “NO” in the menu point “EN.SIL”), and set it back to SIL mode again (choose “YES” in the menu point “EN.SIL” and verify the configuration).

## 16 User interface

### 16.1 Scrolling help texts in display line 3

- |      |  |      |   |
|------|--|------|---|
| [01] | Set correct password                               | [17] | Enter SIL setup   |
| [02] | Enter advanced setup menu?                         |      | Enter simulation mode                                     |
| [03] | Select temperature input                           |      | Enter RAIL setup  |
|      | Select current input                               |      | Perform process calibration                               |
| [04] | Select 0-20 mA input range                         |      | Enter language setup                                      |
|      | Select 4-20 mA input range                         |      | Enter password setup                                      |
| [05] | Select TC sensor type                              |      | Enter display setup                                       |
|      | Select Ni sensor type                              |      | Perform memory operations                                 |
|      | Select Pt sensor type                              | [18] | Load saved configuration into 9113                        |
| [06] | Select Pt10 sensor type                            |      | Save 9113 configuration in 4501                           |
|      | Select Pt20 sensor type                            | [19] | Adjust LCD contrast                                       |
|      | Select Pt50 sensor type                            | [20] | Adjust LCD backlight                                      |
|      | Select Pt100 sensor type                           | [21] | Write a 5-character channel TAG                           |
|      | Select Pt200 sensor type                           | [22] | Show analogue input value in display                      |
|      | Select Pt250 sensor type                           |      | Show analogue output value in display                     |
|      | Select Pt300 sensor type                           |      | Show TAG in display                                       |
|      | Select Pt400 sensor type                           |      | Alternate shown information in display                    |
|      | Select Pt500 sensor type                           | [23] | Enable password protection?                               |
|      | Select Pt1000 sensor type                          | [24] | Set new password  |
| [07] | Select Ni50 sensor type                            | [25] | Select language   |
|      | Select Ni100 sensor type                           | [26] | Select channel to calibrate                               |
|      | Select Ni120 sensor type                           | [27] | Calibrate input low to process value?                     |
|      | Select Ni1000 sensor type                          | [28] | Set value for low calibration point                       |
| [08] | Select TC-B sensor type                            | [29] | Calibrate input high to process value?                    |
|      | Select TC-E sensor type                            | [30] | Set value for high calibration point                      |
|      | Select TC-J sensor type                            | [31] | Use process calibration values?                           |
|      | Select TC-K sensor type                            | [32] | Select channel to simulate                                |
|      | Select TC-L sensor type                            | [33] | Set the input simulation value                            |
|      | Select TC-N sensor type                            | [34] | Enable SIL configuration lock?                            |
|      | Select TC-R sensor type                            |      | 0-20 mA is not a valid output range for SIL operation     |
|      | Select TC-S sensor type                            | [35] | Set Analog output response time in seconds                |
|      | Select TC-T sensor type                            | [36] | Select internal temperature sensor                        |
|      | Select TC-U sensor type                            |      | Select CJC connector (accessory)                          |
|      | Select TC-W3 sensor type                           | [37] | ...is channel using process-compensated calibration data? |
|      | Select TC-W5 sensor type                           | [38] | Configuration SIL status (Open / Locked)                  |
|      | Select TC-Lr sensor type                           | [40] | Sensor wire breakage                                      |
| [09] | Select 2-wire sensor connection                    | [41] | Sensor short circuit                                      |
|      | Select 3-wire sensor connection                    | [42] | Input underrange  |
|      | Select 4-wire sensor connection                    | [43] | Input overrange   |
| [11] | Select Celsius as temperature unit                 | [44] | Input error - check input connections and reset power     |
|      | Select Fahrenheit as temperature unit              | [45] | Output error - check connections and reset power          |
| [12] | Select 0-20 mA output range                        | [46] | Flash memory error - check configuration                  |
|      | Select 4-20 mA output range                        | [47] | Invalid configuration type or version                     |
|      | Select 20-0 mA output range                        | [48] | Hardware error  |
|      | Select 20-4 mA output range                        | [49] | CJC sensor error - check device temperature               |
| [13] | Select no error action - output undefined at error | [50] | CJC error - check CJC connector block                     |
|      | Select downscale at error                          | [51] | No communication  |
|      | Select NAMUR NE43 downscale at error               |      |   |
|      | Select NAMUR NE43 upscale at error                 |      |   |
| [14] | Set temperature for analogue output low            |      |   |
| [15] | Set temperature for analogue output high           |      |   |
| [16] | Enable Rail status signal output?                  |      |   |



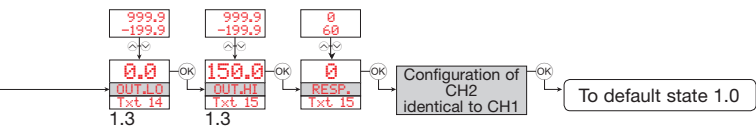

### 16.3 Routing diagram - Advanced settings (ADV.SET)

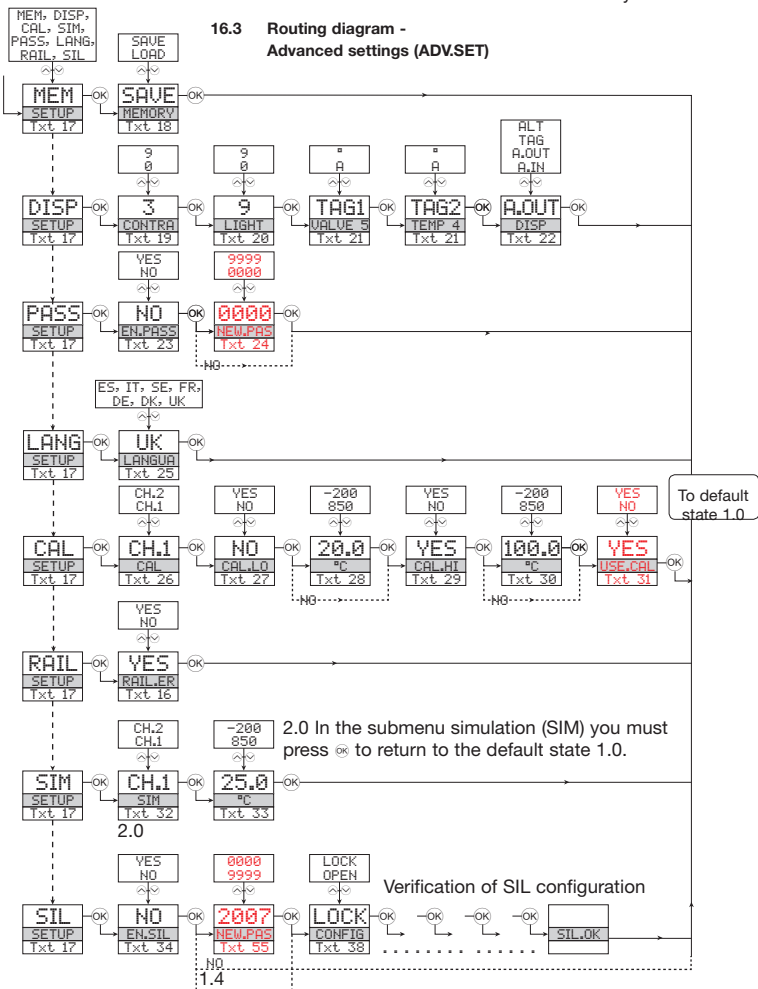

## 17 Connections diagram

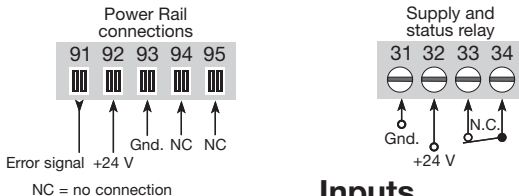

## Inputs

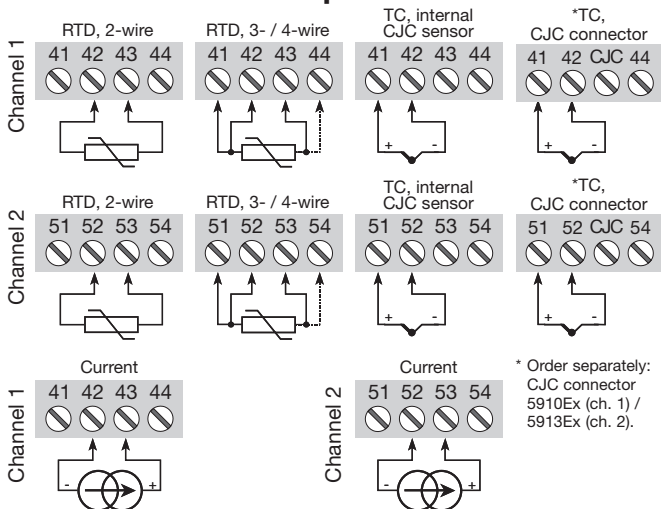

## Outputs





**Displays** Programmable displays with a wide selection of inputs and outputs for display of temperature, volume and weight, etc. Feature linearization, scaling, and difference measurement functions for programming via PReset software.



**Ex interfaces** Interfaces for analog and digital signals as well as HART® signals between sensors / I/P converters / frequency signals and control systems in Ex zone 0, 1 & 2 and for some devices in zone 20, 21 & 22.



**Isolation** Galvanic isolators for analog and digital signals as well as HART® signals. A wide product range with both loop-powered and universal isolators featuring linearization, inversion, and scaling of output signals.





























**Temperature** A wide selection of transmitters for DIN form B mounting and DIN rail devices with analog and digital bus communication ranging from application-specific to universal transmitters.



**Universal** PC or front programmable devices with universal options for input, output and supply. This range offers a number of advanced features such as process calibration, linearization and auto-diagnosis.





- 

[www.preelectronics.fr](http://www.preelectronics.fr)  

[sales-fr@preelectronics.com](mailto:sales-fr@preelectronics.com)
- 

[www.preelectronics.de](http://www.preelectronics.de)  

[sales-de@preelectronics.com](mailto:sales-de@preelectronics.com)
- 

[www.preelectronics.es](http://www.preelectronics.es)  

[sales-es@preelectronics.com](mailto:sales-es@preelectronics.com)
- 

[www.preelectronics.it](http://www.preelectronics.it)  

[sales-it@preelectronics.com](mailto:sales-it@preelectronics.com)
- 

[www.preelectronics.se](http://www.preelectronics.se)  

[sales-se@preelectronics.com](mailto:sales-se@preelectronics.com)
- 

[www.preelectronics.com](http://www.preelectronics.com)  

[sales-uk@preelectronics.com](mailto:sales-uk@preelectronics.com)
- 

[www.preelectronics.com](http://www.preelectronics.com)  

[sales-us@preelectronics.com](mailto:sales-us@preelectronics.com)
- 

[www.preelectronics.cn](http://www.preelectronics.cn)  

[sales-cn@preelectronics.com](mailto:sales-cn@preelectronics.com)
- 

[www.preelectronics.be](http://www.preelectronics.be)  

[sales-be@preelectronics.com](mailto:sales-be@preelectronics.com)

## Head office

Denmark  
 PR electronics A/S  
 Lerbakken 10  
 DK-8410 Rønde

[www.preelectronics.com](http://www.preelectronics.com)  
[sales-dk@preelectronics.com](mailto:sales-dk@preelectronics.com)  
 tel. +45 86 37 26 77  
 fax +45 86 37 30 85



QUALITY SYSTEM AND ENVIRONMENTAL MANAGEMENT SYSTEM  
 DS/EN ISO 9001  
 DS/EN ISO 14001

